

TENAX



**SUPPORT,
REINFORCEMENT
& PROTECTION**

ENG

Tenax nettings

TENAX is a leading international group of company, based in North Italy, which manufactures **extruded** and **stretched nets**, through the **extrusion** of **thermoplastic polymers**.

THE STRETCHING PROCESS

TENAX has developed and patented an exclusive **mono-axial** and **bi-axial stretching process** for plastic netting, which can orientate the polymer molecules in a regular fashion and provide leading-edge products in terms of physical and mechanical characteristics as well as performance.

Even the lightest nettings, which can reach a weight under 5 g/m², show an exceptional tensile strength and are fully recyclable.

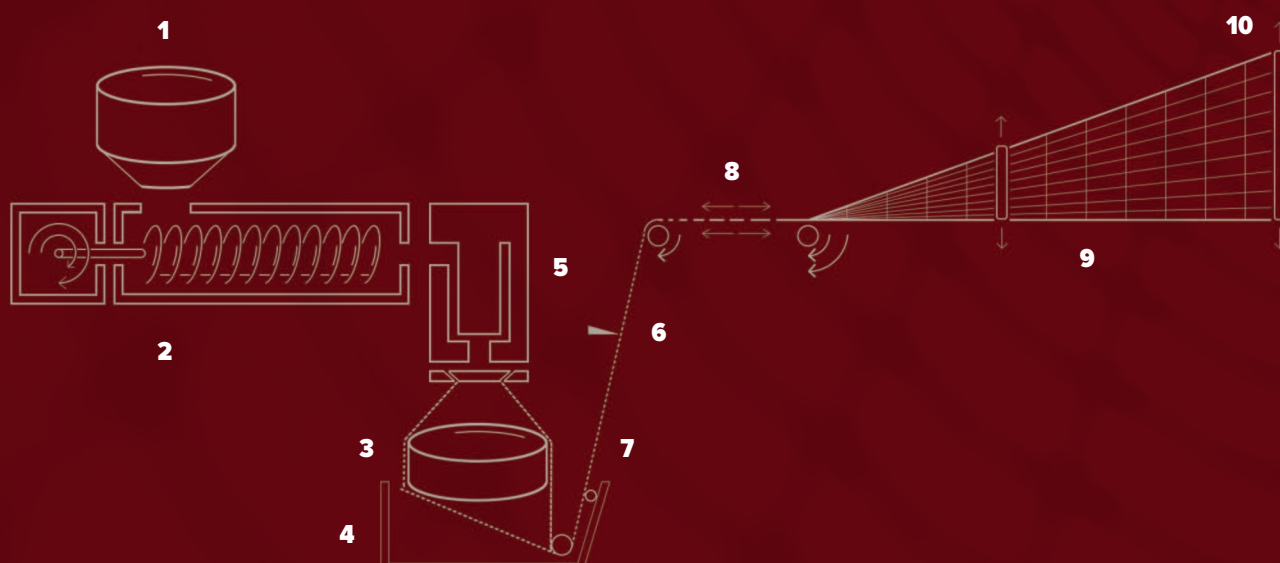

PRODUCT DEVELOPMENT

We create value for our customers.

Our R&D department is focused on the creation of new products requested by our existing and new potential customers, hence the name: **product development center**.

We listen, understand and interpret our customer needs, both the expressed and the unexpressed ones.

The customer needs are then transformed in well-defined and measurable product specifications using a structured and robust methodology.

We use our existing capabilities at best to develop new products. This is what we call **product customization**.

Furthermore, we develop **brand new product** introducing new technologies and materials to satisfy the most demanding needs.

A well-defined process is used both for **product development** and **customization** thus ensuring the best quality of the product to gain the maximum **customer satisfaction**.

DETAILS

- 1 POLYMER
- 2 EXTRUSION
- 3 CALIPER
- 4 COOLING TANK
- 5 DIE
- 6 CUTTING
- 7 EXTRUDED NET
- 8 LONGITUDINAL STRETCHING
- 9 TRANSVERSAL STRETCHING
- 10 STRETCHED NET

Support & reinforcement

TENAX extruded bi-oriented (bi-axially stretched) nets have many applications as reinforcement in the production of industrial fabrics, laminar composites, plastic, paper and for the structural support of polyurethane seats for cars, trains and planes.

Unlike woven structures, extruded bi-oriented nets have the clear advantage of being ladder-proof and maintain high dimensional stability throughout the production process. This enables to obtain products whose physical-mechanical characteristics are the ideal complement to fabric, wrap or paper.

The molecular orientation process enables to achieve uniform mechanical characteristics, even on nets that exceed 4 meters in width, so that the performance of the finished product is remarkably increased. Bioriented nets are produced with weights and meshes suitable for any application.

Advantages

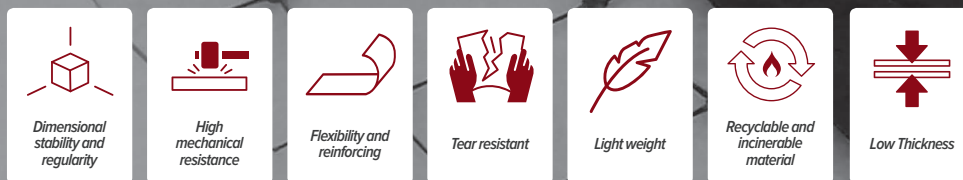

Physical / mechanical features

Maximum width	6,00 m
Minimum thickness	0,23 mm
Maximum thickness	0,70 mm
Color	clear/ customized
Mesh	square
Minimum weight	5 g/m ²
Resistance	up to 6 kN/m

Articles

Light weight nettings R type

ARTICLE	WEIGHT [g/m ²]	MESH SIZE [mm]		TENSILE STRENGHT [kN/m]	
		MD	TD	MD	TD
R 16-t	5.4	8.0	12.0	0.5	0.7
R 11	5.7	8.0	10.0	0.5	0.7
R 24	5.7	6.5	6.5	0.5	0.7
R 17	8.0	12.7	12.7	0.6	0.8
R 12	12.0	10.0	12.0	1.0	1.2
R 22	10.0	4.1	4.3	0.9	1.2
R 18	15.0	12.7	12.7	1.0	1.5
R 9	35.0	7.0	9.0	2.2	3.4

Bi-oriented nets S type

ARTICLE	WEIGHT [g/m ²]	MESH SIZE [mm]		TENSILE STRENGHT [kN/m]	
		MD	TD	MD	TD
S 40	8.0	12.7	12.7	0.9	0.9
S 31	14.0	16.0	19.0	1.0	1.0
S 25	28.0	12.0	12.0	2.2	2.2
S 5	30.0	15.0	18.0	2.3	2.6
S 44	33.0	6.8	7.0	2.5	3.0
S 17	35.0	12.0	12.0	2.7	3.5
S 11	40.0	6.0	6.5	2.5	2.0
S 12	55.0	4.0	4.0	2.7	2.7
S 35	100.0	12.0	12.0	1.8	6.5

Pallet nettings A type & large knot nets LS type

ARTICLE	WEIGHT [g/m ²]	MESH SIZE [mm]		TENSILE STRENGHT [kN/m]	
		MD	TD	MD	TD
A- 1	15.0	19.0	19.0	1.4	1.2
A- 2	7.2	35.0	20.0	1.0	0.4
A- 9	9.0	65.0	40.0	1.4	0.4
LS - 3	9.0	15.0	15.0	0.7	0.7
LS - 4	40.0	11.0	9.5	1.8	2.0
LS - 6	35.0	9.0	9.0	3.1	1.3

Flow media for composite industry

TENAX provides with smart solutions for infusion in the composite industry. Dual-flat rhomboidal meshes show a great effectiveness if used as flow media during the vacuum assisted resin infusion (VARI). These kind products, belonging to the so-called OS family, can be made of high-density polyethylene, polypropylene and polyamide, according to the temperature resistance and chemical compatibility required.

The usual layer-configuration of a composites mold includes the following items: the reinforcement fibers, the “peel ply” (to help the adhesion and the after-work separation), the flow media mesh and the bagging film with the nozzle to inject the resin. Once the air inside the bag is sucked, the epoxy constituent can flow inside. Thanks to the channels created by the grid, the fluid manages to reach any field of the composite surface with no risk of inconsistency or voids in the final product.

The usage of this kind of grids allows the uniform distribution of mechanical and geometrical features throughout the mold and maintains the flow speed under control.

The so-manufactured composites are suitable as wind blades, light plane wings, boat hulls and all the applications, which reaches a high mechanical stress rate.

Advantages



Physical / mechanical features

Maximum width	2000 mm
Minimum thickness	0,40 mm
Maximum thickness	3,80 mm
Min pitch MD	2,30 mm
Min pitch TD	1,40 mm
Color	Colorless

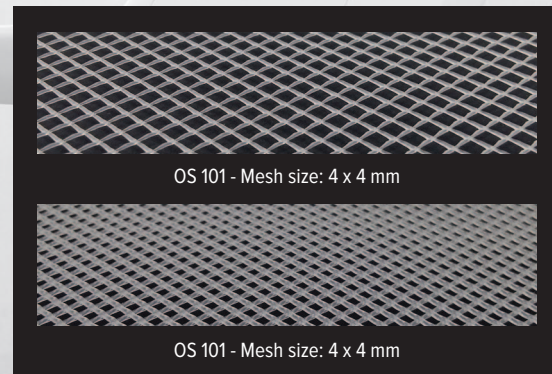

Articles

ARTICLE	POLYMER	THICKNESS [mm]	WEIGHT [g/m ²]	PITCH [mm]		OPENING [mm]	
				MD	TD	MD	TD
OS 2 PA	PA6	0.55	115	3.30	1.90	2.40	1.45
OS 050	cPP	0.65	110	2.60	1.90	2.20	1.50
OS 1 PA	PA6	0.65	140	3.30	1.90	2.40	1.45
OS 3 PA	PA6	0.70	180	3.30	1.90	2.40	1.45
OS 101	cPP	0.72	80	4.00	4.00	3.50	3.50
OS 105	cPP	0.90	100	4.00	4.00	3.00	3.00
OS 107	cPP	1.10	190	3.20	3.10	2.80	2.70
OS 100	cPP	1.20	180	4.00	4.00	3.00	3.00

Rail car cover net

TENAX bi-oriented (or stretched) polypropylene nettings are a safe and cheap solution to transport scrap iron on rail car. Thanks to the very simple installation, this net is mainly used for covering goods on wagons during the transportation of scrap.

The high tensile strength of the mesh, in agreement with the UIC international regulations, allows the net to be fixed in every single mesh along the edge of the rail car.

Advantages



Physical / mechanical features

Color	black
Mesh	square

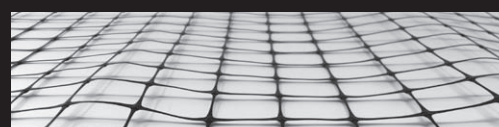

S 22 - Mesh size: 30 x30 mm

Articles

ARTICLE	MESH [mm]	TENSILE STRENGTH [kN/m]		OPENING [mm]
		MD	TD	
S 22	30 x 30	5.0	5.0	4.2
S 22 HW	30 x 30	4.5	6.0	4.2
S 2	30 x 26	4.0	4.0	3.8

Sod reinforcement net

Outstandingly strong and versatile, RADIX, developed by TENAX, is made to optimize the production of turf rolls. Its specific mesh shape let the roots grow through and make a thicker sod in a shorter time. This allows more harvestings per year and decreases the risk of waste during collection. TENAX RADIX is an extruded net made of polypropylene specially conceived to increase the productivity and the quality of sod. This bi-oriented (stretched) product is extremely light (just 7 g/m²) but at the same time very strong. TENAX RADIX must be simply unrolled on the ground before sowing. A thin layer of soil is then laid over. The growing process will start soon. As the seedlings germinate and the roots grow, rhizomes intertwine with the netting to build a stronger structure. This allows early harvesting and stronger sods. There's a new innovative solution for Turf Growers, TENAX RADIX OXO, which offers all the advantages of a polypropylene netting without the disadvantages of the long-lasting presence of plastic under the ground after installation. TENAX RADIX OXO (OXO-degradable) has been studied to start the degradation process in 10 to 24 months depending on environmental factors.

Physical / mechanical features

Storage temperature	20 - 25 °C
Color	green / brown
Mesh	square
Storage condition	dry
Possible additive	OXO

Advantages



RADIX - Mesh size: 35 x 20 mm

Articles

ARTICLE	MESH SIZE [mm]	WIDTH [mm]	LENGHT [m]	ROLL DIAM. [mm]	WEIGHT [g/m ²]
RADIX	35 x 20	4.72	3048	0.33	7.0
RADIX	35 x 20	4.72	7620	0.50	7.0
RADIX	35 x 20	5.25	7620	0.50	7.0
RADIX	35 x 20	5.85	7620	0.50	7.0
RADIX PLUS	35 x 20	5.25	7620	0.52	8.0
RADIX PLUS	35 x 20	5.25	7620	0.52	8.0
RADIX 9	45 x 20	4.72	3048	0.33	7.0
RADIX 9	45 x 20	4.72	7620	0.46	7.0
RADIX OXO	35 x 20	5.25	7620	0.54	7.0

Support netting for erosion control blankets

TENAX bi-oriented (or stretched) polypropylene nettings show outperforming features on lightness and mechanical resistance. They can be easily coupled with natural or wooden fibers to realize erosion control blankets for embankments or slopes. Dimensions of the rolls, mesh size and thickness are usually customized according to specific requirements.

We provide the outer supports of the anti-erosion blankets as well as the pleated plastic grid in-between. Bi-oriented nets for this purpose are manufactured on request.

Advantages



Physical / mechanical features

Color	green / brown / black
Mesh	square
Additives	OXO; Photosensitive

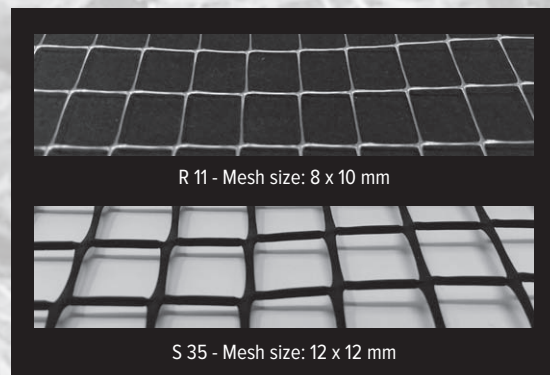

Articles

ARTICLE	MESH SIZE [mm]	WIDTH [mm]	LENGHT [m]	WEIGHT [g/m ²]	FUNCTION
R 11	8 x 10	2.10	6000	5.7	support
R 11 phot.	8 x 10	2.40	10000	5.7	support
R 11	8 x 10	2.50	6000	5.7	support
S 40	12,7 x 12,7	2.45	10000	8.0	support
S 38	12 x 12	2.00	1000	40.0	support
S 22	30 x 30	2.45	500	47.0	support
PL 165	13 x 17	2.25	200	47.0	Pleated spacer
S 35	12 x 12	2.20	500	100.0	Pleated spacer

Packaging & Protection

TUBULAR SLEEVES FOR HANDLING & PROTECTION

TENAX TP nets are designed to protect items against collision and damage caused by contact rubbing, events that often take place during handling and storage in the warehouse or during the shipment of parts packaged without protection.

TENAX TP nets are polyethylene tubular nets recommended for the protection of semi-finished mechanical parts with high finishing and precision, items with painted, galvanized, electropolished or zinc-plated surfaces.

We have specifically designed two different types:

- ELASTIC: elastic nets that adapt perfectly to the most irregular forms
- PROTECTIVE: a wide range of protective nets, against any risk

The fact that the nets can be used several times reduces the production of rejects and decreases costs.

Advantages



Articles

Elastic sleeves

ARTICLE	ø [mm]		ROLL LENGTH [mm]	COLOUR
	min	max		
TP 20/15	20	50	200	colourless
TP 45	35	80	200	blue
TP 95	50	100	200	pink
TP 140	70	160	200	ochre
TP 210	120	250	50	black

Protective sleeves

ARTICLE	ø [mm]		ROLL LENGTH [mm]	COLOUR
	min	max		
TP 5	7	15	200	colourless
TP 10	10	20	200	violet
TP 15	15	30	200	light blue
TP 20	25	50	200	blue
TP 50	35	70	200	yellow
TP 75	50	75	200	brown
TP 100	50	100	200	red
TP 150	75	150	50	orange
TP 180	120	200	50	light green
TP 200	100	200	200	dark green
TP 220	125	250	100	colourless
TP 230	150	300	100	blue

PROTECTIVE SLEEVINGS FOR CERAMICS AND METAL ITEMS

Tubular plastic nets to protect pottery wares or big dimension items.

TENAX offers a unique variety of expanding mesh sleeves with an outstanding resistance and elasticity.

This range of high-stretch protective mesh is flexible enough to fit around irregular shapes and is tough enough to withstand knocks and scratches.

PS nets are supplied in rolls and are available in cut pieces if required. They are both reusable and recyclable.

Advantages



Physical / mechanical features

Mesh	rhomboidal
Possible additives	AUV

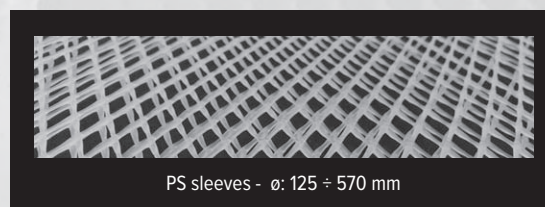

Articles

ARTICLE	POLYMER	ϕ [mm]		ROLL LENGHT [m]	COLOUR
		min	max		
PS 400	LDPE	210	300	80	Blue
PS 500	LDPE	150	210	20	Colourless
PS 600	LDPE	220	380	30	red
PS 950	LDPE	190	250	30	Colourless
PS 1150	LDPE	250	400	30	Colourless
PS 1200	LDPE	350	550	30	Colourless
PS 1400	LDPE	310	460	80	Orange
PS 1600	LDPE	560	570	80	Colourless
PS-E 125	EVA	125	300	80	Colourless
PS-E 170	EVA	170	500	80	Colourless

FLAT MESHES FOR SEPARATION OF MECHANICAL PARTS

Flat polyethylene nets for the separation and protection of manufactured and semi-finished mechanical products against collision and damage due to contact. They allow items and mechanical parts to be layered even if not perfectly dry, because they avoid the formation of condensate on the surface. The fact that the nets can be used several times reduces the production of rejects and decreases costs.

Advantages



Physical / mechanical features

Mesh	Square / rhomboidal
Possible additives	AUV

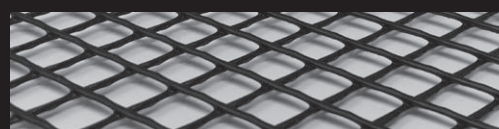

CN 1 - Mesh size: 12 x 8 mm

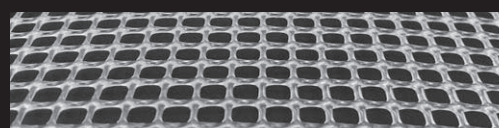

CN 35 - Mesh size: 4,6 x 4,6 mm

Articles

ARTICLE	POLYMER	THICKNESS [mm]	WEIGHT [g/m ²]	MESH SIZE [mm]		MEASURES [m]	COLOUR
				MD	TD		
CN 1	HDPE	2.00	375	12.0	8.0	0,80 x 50	Black
CN 2	HDPE	1.40	400	7.0	5.0	1,00 x 50	Black
CN 7	HDPE	1.00	250	10.5	6.0	0,80 x 50	Black
CN 35	hPP	1.00	200	4.7	4.7	1,18 x 50	colourless
CN 40	HDPE	0.75	164	3.5	3.5	0,76 x 50	Black
CE 402	HDPE exp.	6.00	1200	11.0	10.0	1,2 x 20	Black

Compostable nets & environment

TENAX manufactures through its extrusion technology nettings and grids made of compostable polymers. Our light elastic sleeves, made of a raw material coming from corn starch, show good mechanical and elastic properties, are incinerable and, most of all, are environmental friendly. They were mainly conceived as a non-polluting packaging unit, but they find nowadays applications in many industrial sectors too. Our knowledge allows us to extend the range of these compostable articles to protective grids, support nettings and thicker sleeves. TENAX strongly believes in the future of bio-plastics and welcomes any new requests of product development on this field.

Advantages

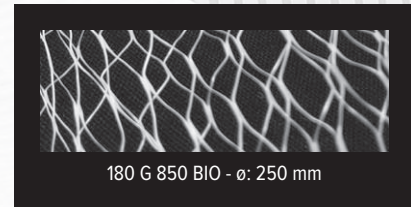

Nettings for food industry

TENAX manufactures many flat and bi-planar grids, which are certified according to EU (EU Reg. 10/2011) and American (FDA) laws. These nettings can be used inside domestic appliances as protective membranes or spacers, as well as in the food industry for fruits or vegetables drying. The maximum working temperature is 80°C (176°F) for polyethylene and 100°C (212°F) for polypropylene nettings.

Advantages

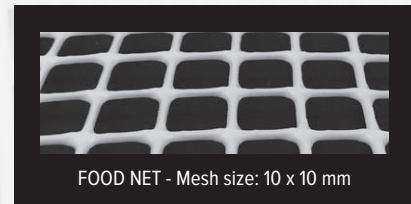

Articles

ARTICLE	POLYMER	THICKNESS [mm]	WEIGHT [g/m ²]	PITCH [mm]		OPENING [mm]	
				MD	TD	MD	TD
OS 050	cPP	0.65	110	2.60	1.90	2.20	1.50
OS 101	cPP	0.72	80	4.00	4.00	3.50	3.50
OS 105	cPP	0.90	100	4.00	4.00	3.00	3.00
OS 107	cPP	1.10	190	3.20	3.10	2.80	2.70
OS 100	cPP	1.20	180	4.00	4.00	3.00	3.00
FOOD NET	HDPE	1.50	270	10.00	10.00	9.00	9.00
S 22 HW nt	hPP	-	58	30.00	30.00	-	-

Raw materials

TENAX nets for industry are manufactured thanks to the extrusion of polyolefins and polyamides, which allow for a very good resistance against almost all chemicals and even micro-organisms such as spores, molds, and bacteria. These raw materials vary among them in some peculiar features.

hPP - Homopolymer polypropylene

- Specific weight: 0.9-0.915 g/cm³ (56.19-57.12 lb/ft³)
- Melting temperature: 162-168°C (323.6-334.4°F)
- Tensile strength: 34-37 MPa
- Young's modulus: 1200-2000 Pa
- Yield elongation: 5-10%
- Break elongation: 500-700%
- Working temperature: +0°C – +90°C (32°F – 194°F)
- Max working temperature (short period): +100°C (212°F)

Light material, resistant to chemical substances (as salts, acids and strong alkalis) and with a high mechanical strength. It is used for bi-oriented (stretched) products. Suitable for direct food contact.

HDPE - High-density polyethylene

- Specific weight: 0.94-0.96 g/cm³ (58.68-59.93 lb/ft³)
- Melting temperature: 126-135°C (258.8-275°F)
- Tensile strength: 25-35 MPa
- Young's modulus: 800-1400 Pa
- Yield elongation: 10-12%
- Break elongation: >800%
- Working temperature: -40°C - +70°C (-40°F – 158°F)
- Max working temperature (short period): 75°C (167°F)

Outperforming chemical and good mechanical resistance. Within the polyethylene family it is the one which can stand at best high and low temperatures. It's used for both extruded and stretched grids.

LDPE - Low-density polyethylene

- Specific weight: 0.915-0.920 g/cm³ (57.12-57.43 lb/ft³)
- Melting temperature: 105-118°C (221-244.4°F)
- Tensile strength: 10-25 MPa
- Young's modulus: 150-300 Pa
- Yield elongation: -
- Break elongation: 550-600%
- Working temperature: -70°C - +40°C (-94°F – 104°F)
- Max working temperature (short period): 50°C (122°F)

Very soft material. It is mostly used for elastic sleeves for protecting goods. Can stand really low temperature.

cPP - Copolymer polypropylene

- Specific weight: 0.895-0.9 g/cm³ (54.62-56.19 lb/ft³)
- Melting temperature: 135-168°C (275-334.4°F)
- Tensile strength: 25-30 MPa
- Young's modulus: 1000 Pa
- Yield elongation: 5-10%
- Break elongation: >500%
- Working temperature: -20°C – 70°C (68°F – 158°F)
- Max working temperature (short period): +80°C (176°F)

Slightly softer and more resistant to high temperature than the homopolymer but with similar mechanical features. Suitable for direct food contact.

LLDPE – Linear low-density polyethylene

- Specific weight: 0.92 g/cm³ (57.43 lb/ft³)
- Melting temperature: 114-125°C (237.2-257°F)
- Tensile strength: 20-30 MPa
- Young's modulus: 150-400 Pa
- Yield elongation: -
- Break elongation: 600-800%
- Working temperature: -70 +50°C (-94°F – 122°F)
- Max working temperature (short period): +60°C (140°F)

PA6 (Nylon) - Polyamide 6

- Specific weight: 1.12-1.14 g/cm³ (69.91-71.16 lb/ft³)
- Melting temperature: 220-225°C (428-437°F)
- Tensile strength: 80 MPa (dry) –55 MPa (wet)
- Break elongation: 20-40% (dry) – 100% (wet)
- Working temperature: -40°C – 105°C (-40 – 221°F)
- Max working temperature (short period): 170°C (338°F)

It is an advanced polymer able to stand high temperatures and direct contact with oil, grease, fuel and other solvents. It shows a low friction coefficient and is resistant to abrasion, shocks and fatigue.

EVA – Ethylene-vinyl acetate

- Specific weight: 0.93 g/cm³ (58.06 lb/ft³)
- Melting temperature: 96°C (204.8°F)
- Tensile strength: 25-30 MPa
- Break elongation: 550-900%

Similar to gum.

It's very flexible and extremely elastic.

It shows outperforming insulating qualities and great resistance to low temperature.

It's hypoallergenic and not toxic.

Compostable Biopolymer

- Specific weight: 1.19 [g/cm³]
- Melting temperature: 145-150[°C]
- Tensile strength: 30 [MPa]
- Young's modulus: 450 [Pa]
- Break elongation: 450 [%]

Compostable raw material of plant origin.

It is used for cast (extruded) and mono-oriented products.

Limited mechanical properties.

The values showed are referred to a film production, since this material has been originally developed for this purpose.

“TENAX specializes in high-end plastics and services that create customer and corporate value.”

TENAX

Via dell'Industria 3, 23897 Viganò (LC)

Tel. +39 039 92191

Fax +39 039 9219290

www.tenax.net

pep@tenax.net



SGS ITALY Certificate nr. IT93/0008
SGS UK Certificate nr. IT93/2568